

Sistema Isolado Ibura II

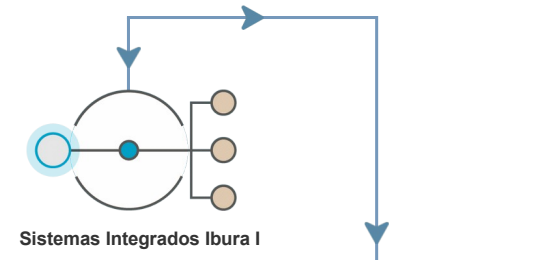

Sistema Isolado Cabrita

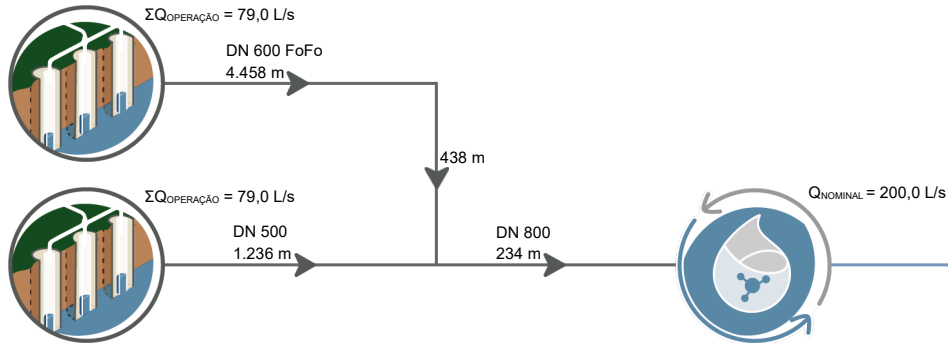
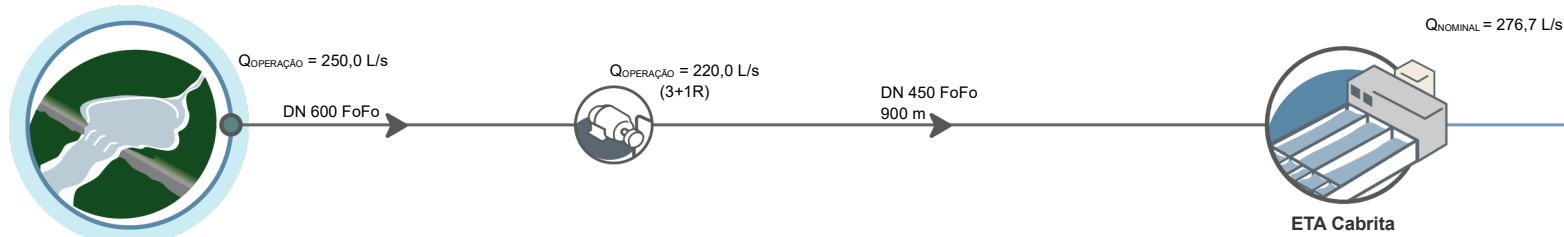

Barragem de Nível no Rio Pitanga
Q_{OPERAÇÃO} = 220,0 L/s

ETA Cabrita

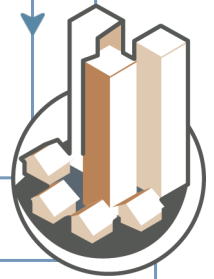

Aracaju

Sistema Isolado Poxim II

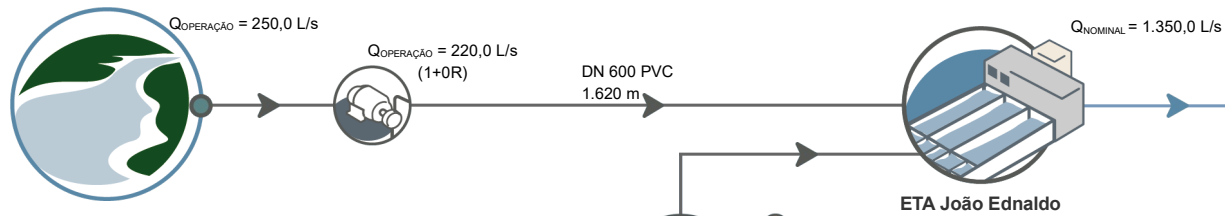

Rio Poxim

ETA João Ednaldo

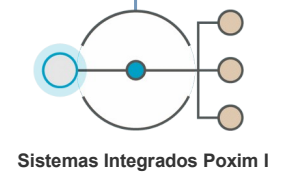
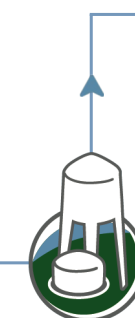

Sistema Integrado São Francisco - Aracaju

Execução:



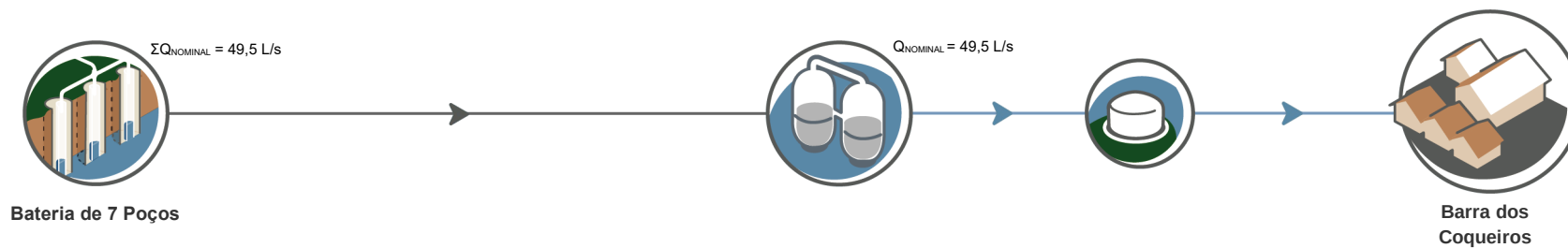

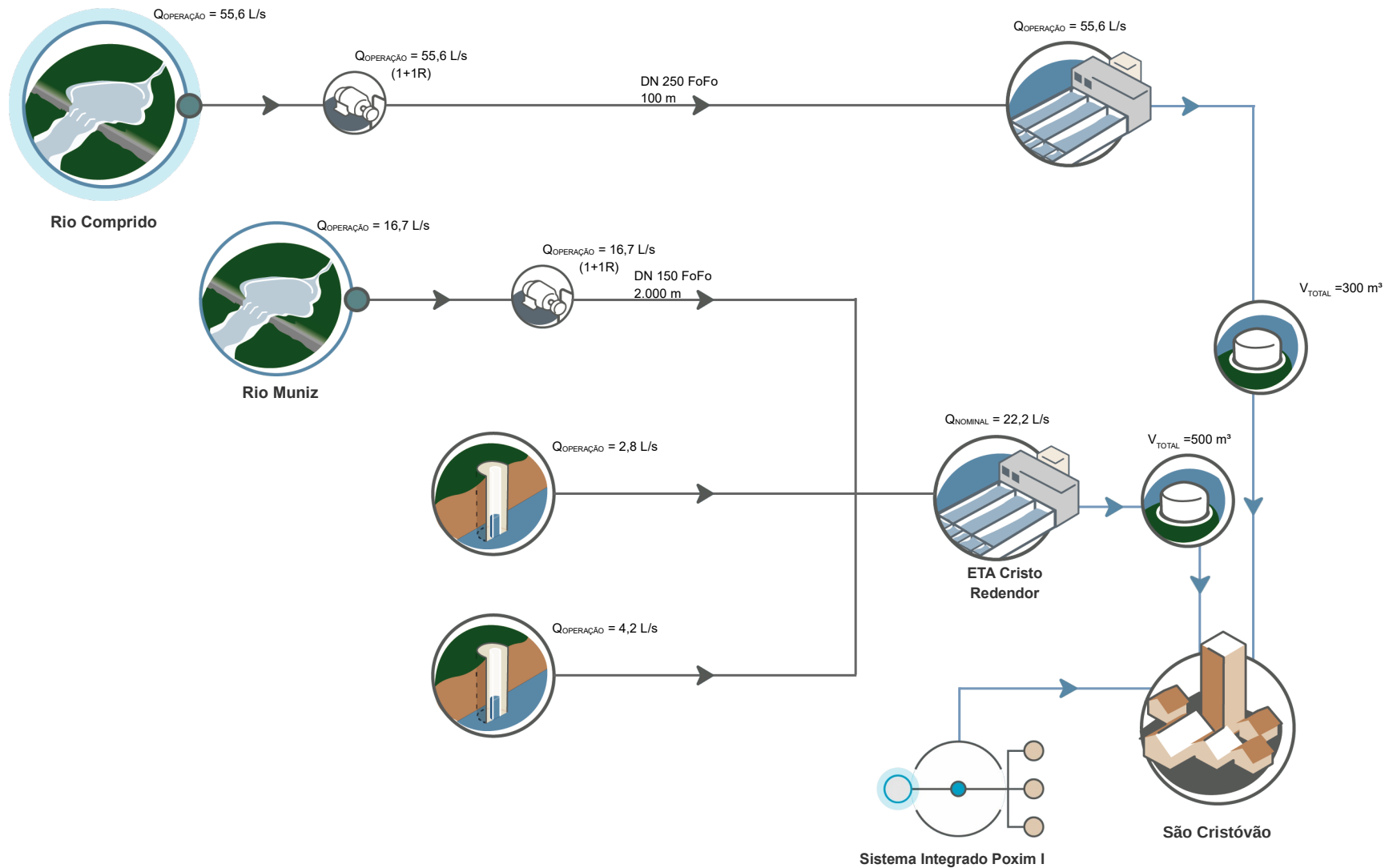

Sistema Integrado Ibura 1 | SE

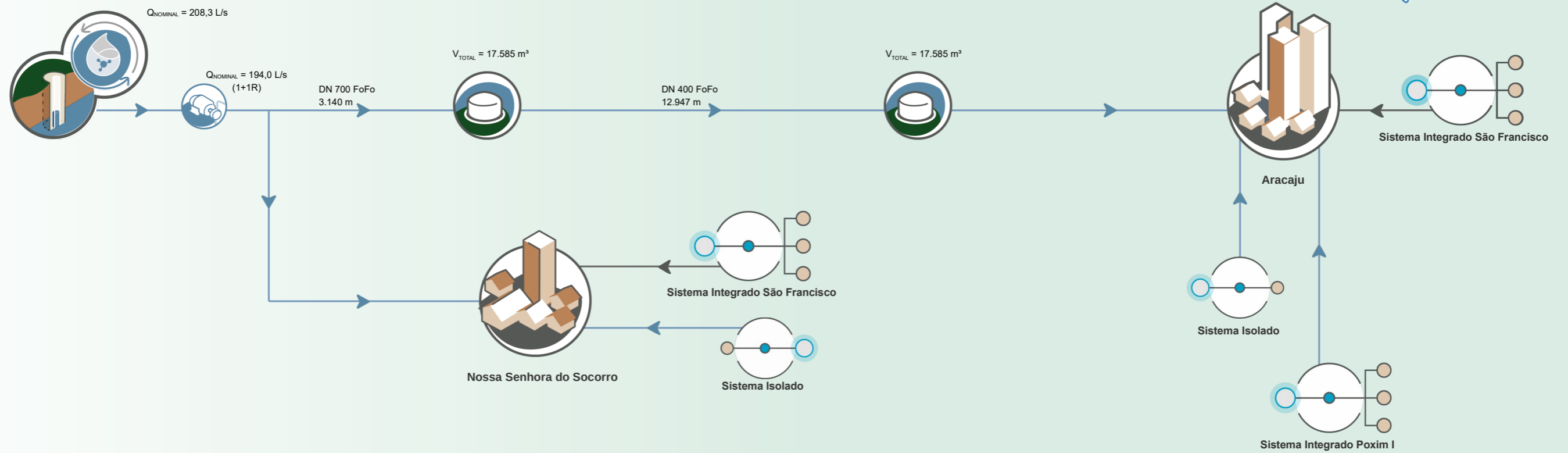

Sistema Integrado Poxim 1 | SE

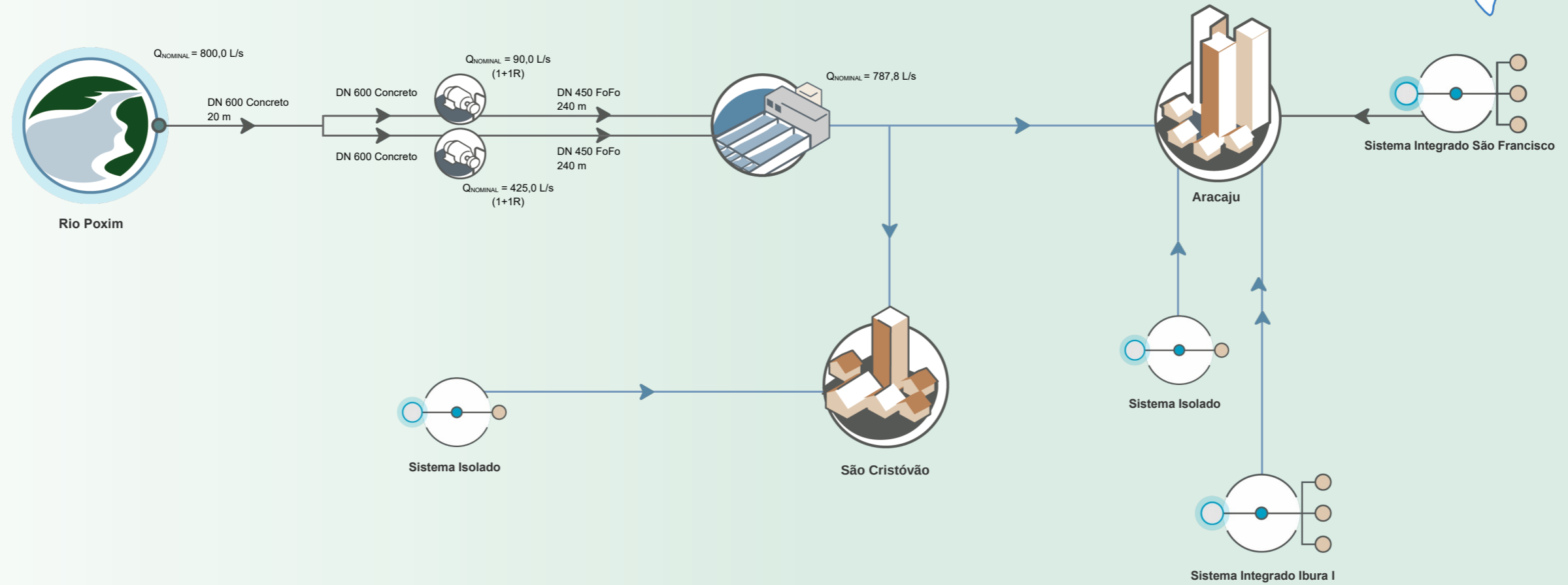
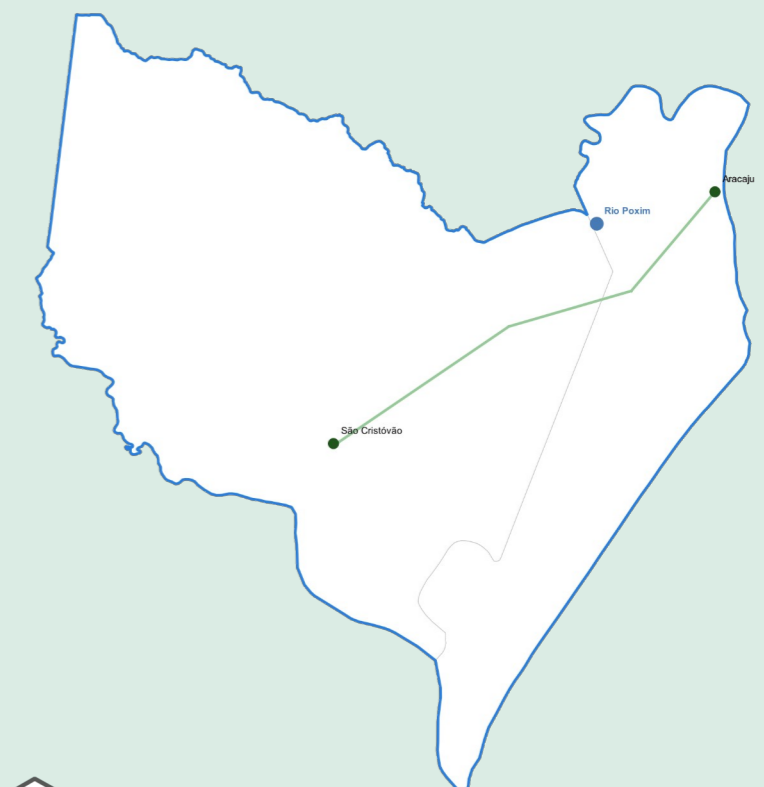

Sistema Integrado São Francisco - Aracaju | SE

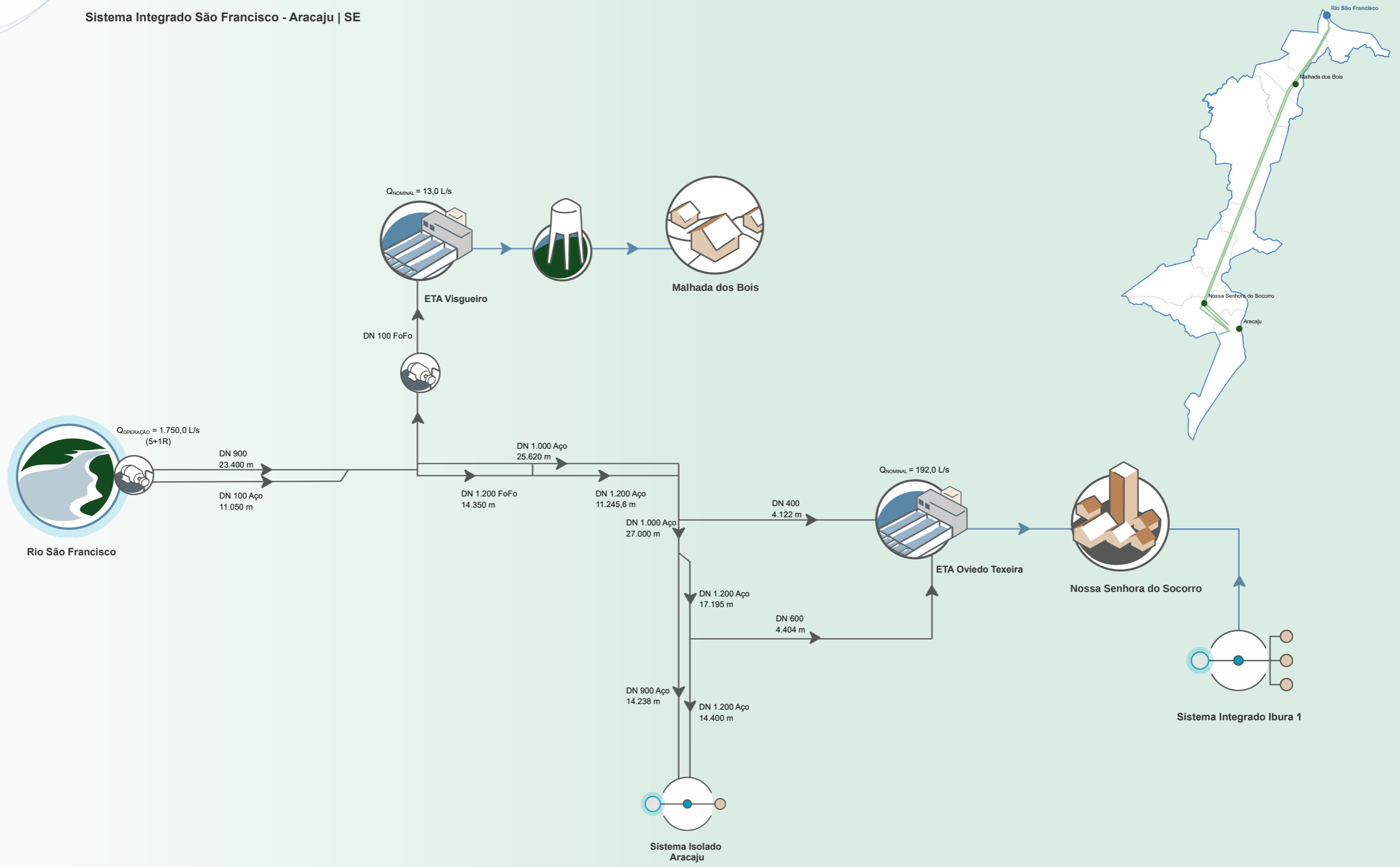

Sistema Integrado São Francisco



$Q_{\text{NOMINAL}} = 192,0 \text{ L/s}$

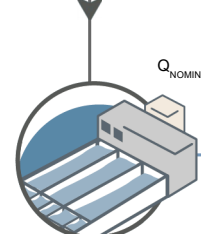

ETA Oviedo Teixeira

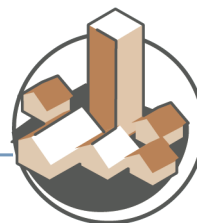

Nossa Senhora do Socorro

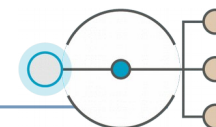

Sistema Integrado Ibura 1