

Sistema Isolado Acari – Xerém

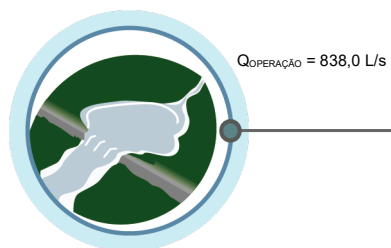

Represa no Rio João Pinto

Sistema Isolado Acari – Mantiquira



Represa no Rio Saracuruna

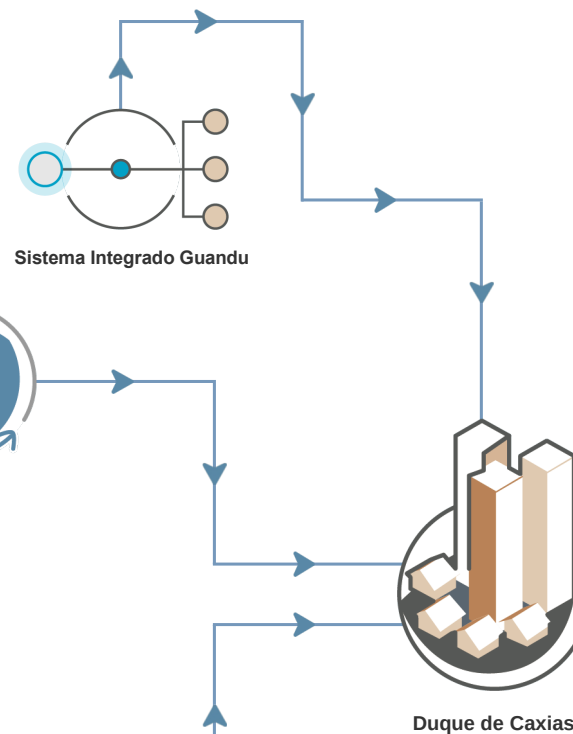

Sistema Isolado Acari – Rio D'Ouro

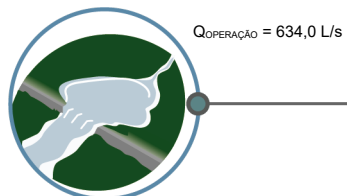

Represa no Rio D'Ouro

Sistema Isolado Acari – São Pedro



Represa São Pedro Superior

Sistema Isolado Acari – Tinguá

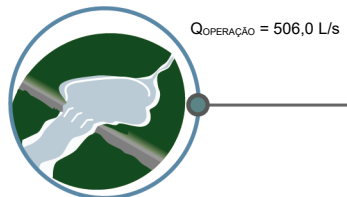

Represa Barrelão

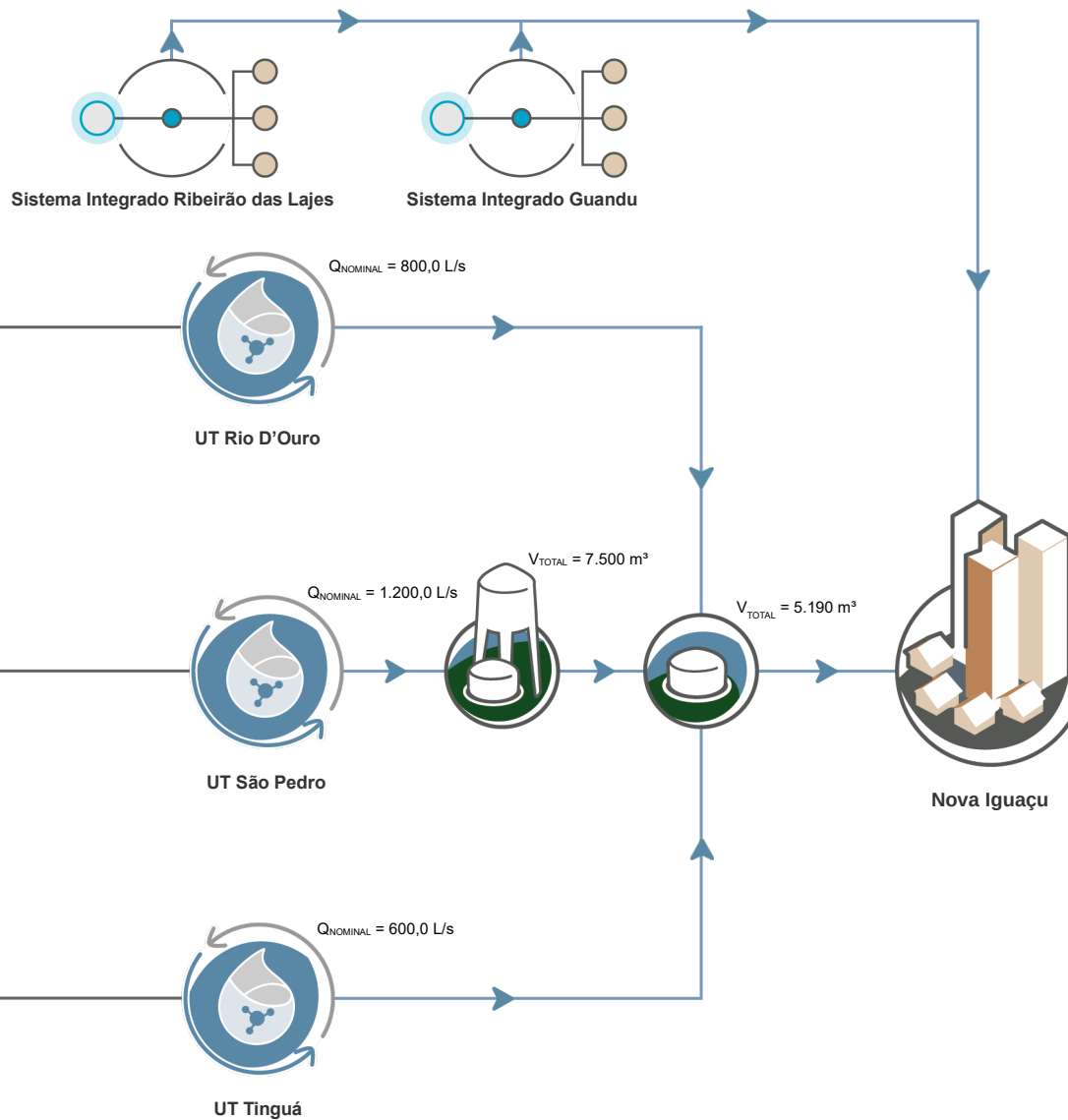

Execução:



Sistema Integrado Ribeirão das Lajes | RJ

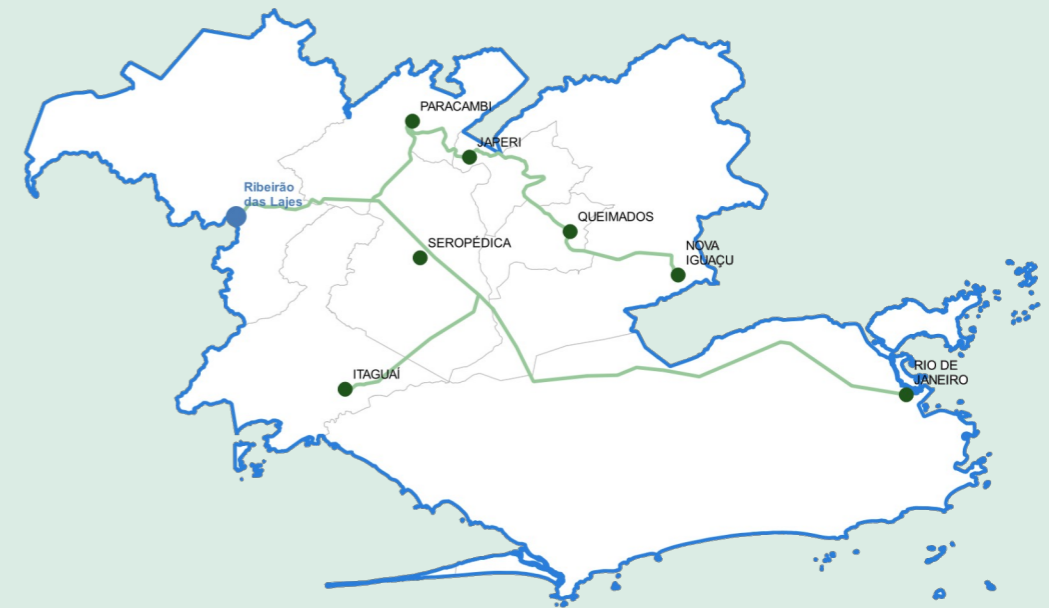
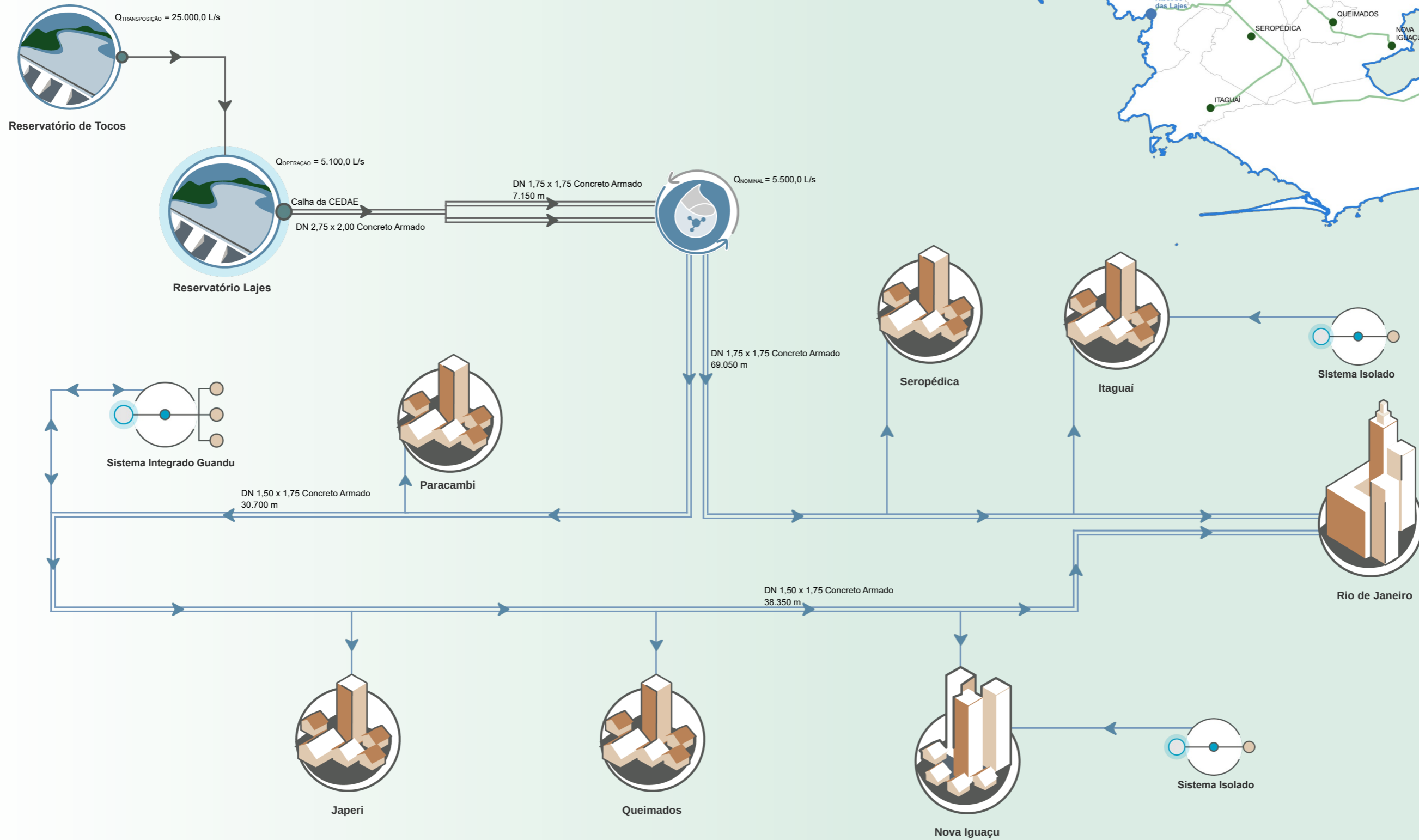

Sistema Integrado Guandu | RJ

